



TOYOTA HYBRID SYSTEM  
**THS II**

**TOYOTA**

## Contents

Introduction .....	1
What is a Hybrid System ? .....	2
Three Objectives of THS II Development .....	4
How the THS II System Works .....	5
High-voltage systems—motor and generator .....	6
Power Control Unit, Battery and Regenerative Braking System .....	8
Hybrid Transmission .....	10
Engine .....	12
System Control .....	14
Output Enhancement .....	18
In-house Development and Production .....	19
Specifications of New Hybrid System .....	20



**The new Prius features THS II, Toyota's next-generation hibrid technology**

# Introduction

New levels of environmental & power performance compatibility based on the concept of Hybrid Synergy Drive



At the 2003 New York Auto Show, TMC President Cho unveiled the all-new Prius with THS II, a “Hybrid Synergy Drive” concept that delivers both higher power and greater fuel economy than the previous Prius.

## In search of the ultimate eco-car

Toyota’s mission has always been to provide clean and safe products. Thus, the company has positioned the environment as one of its most important issues and has been working toward creating a prosperous society and a world that is comfortable to live in. With this goal in mind, Toyota has been actively developing various new technologies from the perspective of achieving energy security and diversifying energy sources, which is necessitated by the dwindling supply of petroleum resources. For example, in motive power sources for automobiles alone, we have been continuously improving conventional engines and have developed and commercialized lean-burn gasoline engines, direct injection gasoline engines and common rail direct-injection diesel engines, etc. We have also been modifying engines so that they can use alternative fuels, such as compressed natural gas (CNG), instead of gasoline or light oil, and have been installing these engines in commercially sold vehicles. Toyota has also developed and has been marketing electric vehicles (EV) that use motors for the driving source; hybrid vehicles (HV) that combine an engine and a motor, fusing the advantages of these two power sources; fuel cell hybrid vehicles (FCHV) that use fuel cells (FC) to generate electricity based on a chemical reaction between hydrogen and the oxygen in the air and that supply this electricity to electric motors to produce driving power.



Toyota Hybrid System II (THS II)

In January 1997, Toyota declared the start of the Toyota Eco Project. As part of this effort, Toyota decided to tackle the international challenge of reducing CO<sup>2</sup> emissions in order to prevent global warming and accelerated the development of a hybrid vehicle with the goal of achieving twice the fuel efficiency of conventional vehicles. Then, in March of the same year, Toyota announced the completion of a new power train called the Toyota Hybrid System (THS) for use in passenger vehicles. This power train combines a gasoline engine and an electric motor, and because it does not require external charging, as do existing electric vehicles, it works within existing infrastructures such as fueling facilities. This system also achieves nearly twice the fuel efficiency of conventional gasoline engines.

THS was installed in the passenger vehicle Prius, which was introduced in December 1997 in the Japanese market as the first mass-produced hybrid passenger vehicle in the world. In 2000, overseas marketing of the Prius began. The Prius has gained a reputation as a highly innovative vehicle, and its cumulative worldwide sales have exceeded 110,000 units. Meanwhile, THS has continued to evolve, and in 2001, THS-C, which combines THS with CVT (continuously variable transmission), was installed in the Estima Hybrid minivan and THS-M (a mild hybrid system) was installed in the Crown, luxury sedan, both for the Japanese market thereby contributing greatly to innovations in the automobiles of the 21st century.

This is all part of our search for the ultimate eco-car.

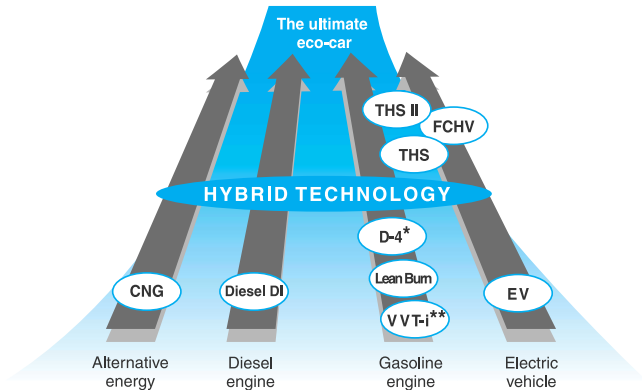

\* Direct Injection 4-stroke Gasoline Engine  
 \*\* Variable Valve Timing with Intelligence

Building on the ecology-focused THS, Toyota has developed the concept of Hybrid Synergy Drive. Based on this concept, Toyota has developed a new-generation Toyota hybrid system called THS II, which achieves high levels of compatibility between environmental performance and power by increasing the motor output by 1.5 times, greatly boosting the power supply voltage and achieving significant advances in the control system, aiming for synergy between motor power and engine power.

Toyota has positioned hybrid technology as its key technology. Beginning with the development of EVs and through the commercialization of HVs and FCHVs, its continued efforts have now culminated in the development of THS II. Toyota will continue to endeavor to make technical advances in this area.

## What is a Hybrid System?

Fusion between an internal combustion engine and electric motor—achieving different functions through different power combinations

Automobile hybrid systems combine two motive power sources, such as an internal combustion engine and an electric motor, to take advantage of the benefits provided by these power sources while compensating for each other's shortcomings, resulting in highly efficient driving performance. Although hybrid systems use an electric motor, they do not require external charging, as do electric vehicles.

### 3 types of Hybrid Systems

The following three major types of hybrid systems are being used in the hybrid vehicles currently on the market:

#### 1) SERIES HYBRID SYSTEM

The engine drives a generator, and an electric motor uses this generated electricity to drive the wheels. This is called a series hybrid system because the power flows to the wheels in series, i.e., the engine power and the motor power are in series. A series hybrid system can run a small-output engine in the efficient operating region relatively steadily, generate and supply electricity to the electric motor and efficiently charge the battery. It has two motors—a generator (which has the same structure as an electric motor) and an electric motor. This system is being used in the Coaster Hybrid.

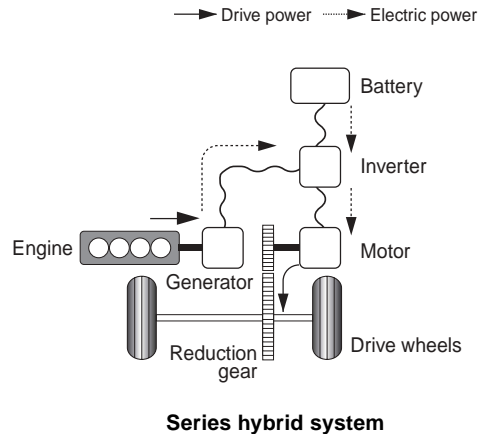

#### 2) PARALLEL HYBRID SYSTEM

In a parallel hybrid system, both the engine and the electric motor drive the wheels, and the drive power from these two sources can be utilized according to the prevailing conditions. This is called a parallel hybrid system because the power flows to the wheels in parallel. In this system, the battery is charged by switching the electric motor to act as a generator, and the electricity from the battery is used to drive the wheels. Although it has a simple structure, the parallel hybrid system cannot drive the wheels from the electric motor while simultaneously charging the battery since the system has only one motor.

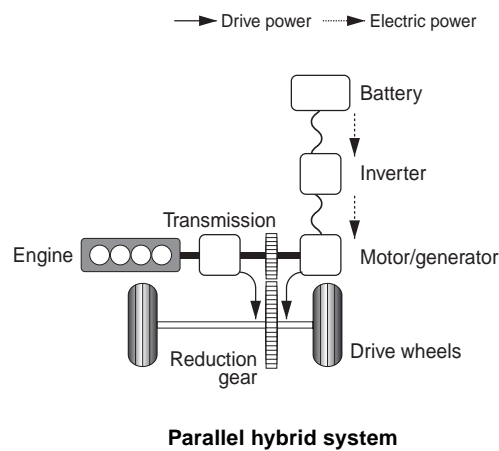

#### 3) SERIES/PARALLEL HYBRID SYSTEM

This system combines the series hybrid system with the parallel hybrid system in order to maximize the benefits of both systems. It has two motors, and depending on the driving conditions, uses only the electric motor or the driving power from both the electric motor and the engine, in order to achieve the highest efficiency level. Furthermore, when necessary, the system drives the wheels while simultaneously generating electricity using a generator. This is the system used in the Prius and the Estima Hybrid.

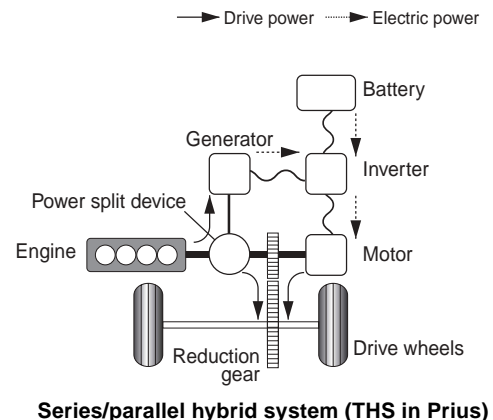

## Engine and Motor Operation in each system

The chart below shows how the ratio of use between engine and motor differs depending on the hybrid system.

Since a series hybrid uses its engine to generate electricity for the motor to drive the wheels, the engine and motor do about the same amount of work.

A parallel hybrid uses the engine as the main power source, with the motor used only to provide assistance during acceleration. Therefore, the engine is used much more than the motor.

In a series/parallel hybrid (THS in the Prius), a power split device divides the power from the engine, so the ratio of power going directly to the wheels and to the generator is continuously variable. Since the motor can run on this electric power as it is generated, the motor is used more than in a parallel system.

Ratio of engine and motor operation in hybrid systems (conceptual diagram)

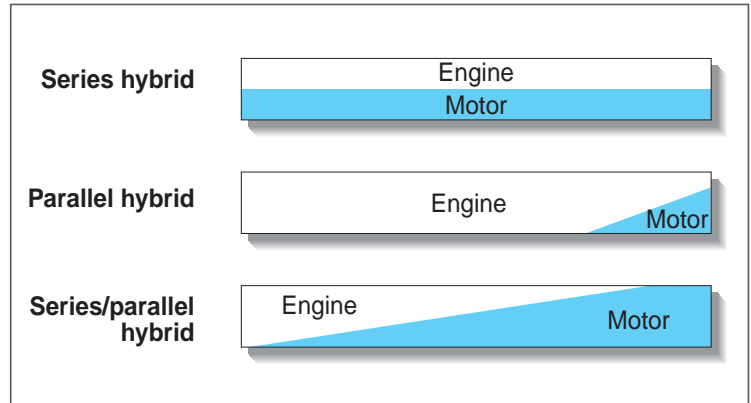

## Characteristics of Hybrid Systems

Hybrid systems possess the following four characteristics:

### 1) ENERGY-LOSS REDUCTION

The system automatically stops the idling of the engine (idling stop), thus reducing the energy that would normally be wasted.

### 2) ENERGY RECOVERY AND REUSE

The energy that would normally be wasted as heat during deceleration and braking is recovered as electrical energy, which is then used to power the starter and the electric motor.

### 3) MOTOR ASSIST

The electric motor assists the engine during acceleration.

### 4) HIGH-EFFICIENCY OPERATION CONTROL

The system maximizes the vehicle's overall efficiency by using the electric motor to run the vehicle under operating conditions in which the engine's efficiency is low and by generating electricity under operating conditions in which the engine's efficiency is high.

The series/parallel hybrid system has all of these characteristics and therefore provides both superior fuel efficiency and driving performance.

Hybrid system comparison

	Fuel economy improvement				Driving performance	
	Idling stop	Energy recovery	High-efficiency operation control	Total efficiency	Acceleration	Continuous high output
Series	●	◎	●	●	○	○
Parallel	●	●	○	●	●	○
Series/parallel	◎	◎	◎	◎	●	●

◎ Excellent ● Superior ○ Somewhat unfavorable

## Three Objectives of THS II Development

A new-generation hybrid system that seeks enhanced efficiency and greater power

### Compatibility of Environmental & Power Performance

Automobiles of the future must increase both environmental and safety performance, while significantly increasing the all-important motor vehicle characteristic of being fun to drive. To achieve superior driving performance, which is the basis for driving enjoyment, the conventional approach has been to increase output and torque by increasing engine displacement or using supercharging. However, this approach decreases fuel efficiency, making it difficult to achieve compatibility of environmental performance and power. In other words, fuel efficiency and power are in a trade-off relationship. By using the Toyota Hybrid System (THS), the Prius was able to escape the inevitability of this relationship in a paradigm shift. The goal of the Hybrid Synergy Drive concept is to achieve compatibility of high levels of both environmental performance and power.

THS, which is a series parallel hybrid, contains a power split device that splits power into two paths. In one path, the power from the gasoline engine is directly transmitted to the vehicle's wheels. In the other path (electrical path), the power from the engine is converted into electricity by a generator to drive an electric motor or to charge the battery. This unique configuration achieves idling stop, stopping of the gasoline engine while the vehicle is running, running of the vehicle using the electric motor, motor assist at any speed, and highly efficient energy regeneration, without using a clutch or transmission. This is achieved through the use of a motor having large low-speed torque and large output.

The newly developed hybrid system, THS II, targets both greater power and improved motor power transmission efficiency, advancing energy management control for the entire vehicle. As a result, Hybrid Synergy Drive has been developed, which markedly increases power performance, improves acceleration performance, and at the same time achieves the highest degree of environmental performance in the world.

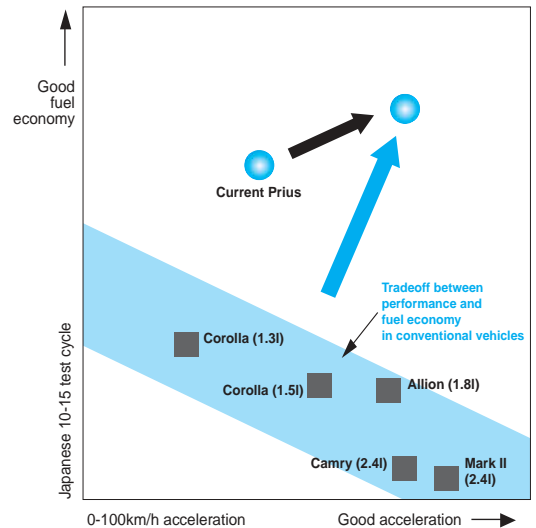

### Pursuit of World's Highest Fuel Efficiency

The new hybrid system THS II is based essentially on THS. In a bid for even higher efficiency, the new system adopts a high-voltage power circuit between the motor and generator, and greatly reduces energy loss during energy transmission to deliver optimal energy efficiency. THS II significantly increases the use of the electric motor, and under conditions in which the engine experiences poor efficiency, the engine is stopped and the vehicle runs using only power from the electric motor. Under conditions in which engine efficiency is high, THS II operates the engine at optimal fuel efficiency and generates optimum electricity. It also achieves greater energy regeneration during deceleration and braking, thereby increasing the electricity input/output efficiency, in pursuit of the world's highest fuel efficiency. In terms of environmental performance, THS II aims to meet the ATPZEV (Advanced Technology Partial Zero Emission Vehicle) Regulations in California, U.S.A, which are proposed to go into effect in 2005, the Ultra-Low Emissions Level in Japan, as well as the EURO IV Regulations, scheduled to go into effect in 2004, thus realizing the world's highest level of clean emissions.

### Innovative Hybrid Vehicle Driving Experience

THS II boasts by 1.5 times more power from the motor thanks to a higher rpm of the engine, motor, and generator. It adopts a high-voltage power circuit and a higher-performance battery for increased power supply. As a result, the motor power and engine power together provide a more powerful yet smoother running performance.

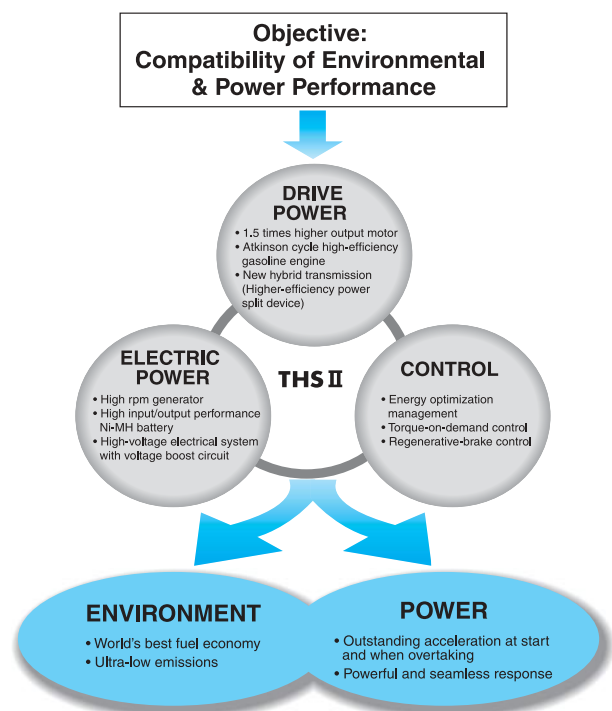

# How the THS II System Works

Superb coordination between engine and motor

Motor power is used for starting the vehicle. For normal operation, the engine and the motor are optimally controlled to increase fuel efficiency. When powerful acceleration is needed, the high-output motor and the engine generate optimum power. This represents further evolution in smooth yet powerful running performance.

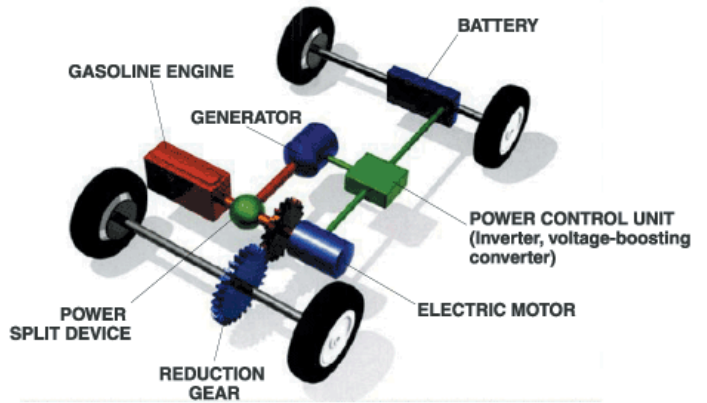

## System Configuration

All of the major components of THS II have been developed by Toyota on its own. The high-voltage power circuit, the motor, the generator and the battery have all been designed anew, enabling further evolution of the hybrid system.

The system consists of two kinds of motive power sources, i.e., a high-efficiency gasoline engine that utilizes the Atkinson Cycle, which is a high-expansion ratio cycle, as well as a permanent magnet AC synchronous motor with 1.5 times more output, a generator, high-performance nickel-metal hydride (Ni-MH) battery and a power control unit. This power control unit contains a high-voltage power circuit for raising the voltage of the power supply system for the motor and the generator to a high voltage of 500 V, in addition to an AC-DC inverter for converting between the AC current from the motor and the generator and the DC current from the hybrid battery. Other key components include a power split device, which transmits the mechanical motive forces from the engine, the motor and the generator by allocating and combining them. The power control unit precisely controls these components at high speeds to enable them to cooperatively work at high efficiency.

## System Operation

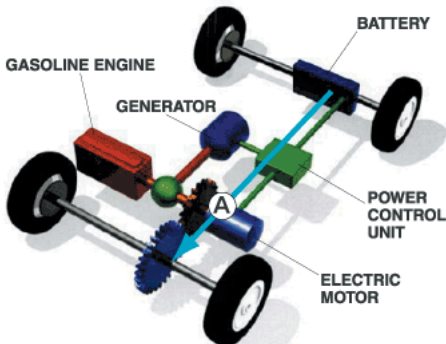

### 1 Start and low to mid-range speeds

The engine stops when in an inefficient range, such as at start-up and in low to mid-range speeds. The vehicle runs on the motor alone. (A)

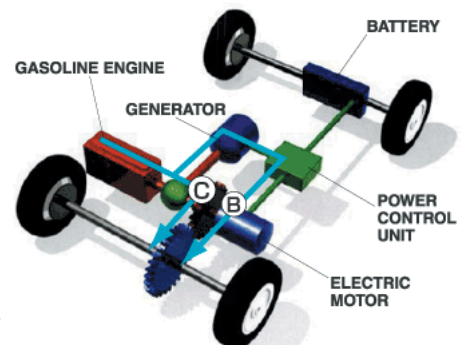

### 2 Driving under normal conditions

Engine power is divided by the power split device. Some of the power turns the generator, which in turn drives the motor. (B) The rest of the power drives the wheels directly. (C) Power allocation is controlled to maximize efficiency.

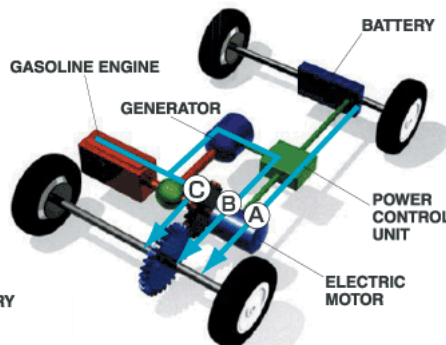

### 3 Sudden acceleration

Extra power is supplied from the battery (A), while the engine and high-output motor provide smooth response (B+C) for improved acceleration characteristics.

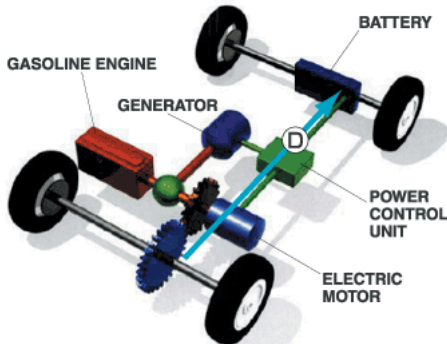

### 4 Deceleration, braking

The high-output motor acts as a high-output generator, driven by the vehicle's wheels. This regenerative braking system recovers kinetic energy as electrical energy, which is stored in the high-performance battery. (D)

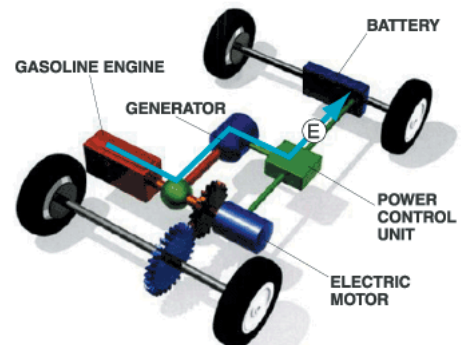

### 5 Battery recharging

Battery level is managed to maintain sufficient reserves. The engine drives the generator to recharge the battery when necessary. (E)

### 6 At rest

The engine stops automatically.

## High-voltage systems — motor and generator

Greater motor output through increased voltage

### High-voltage Power Supply System

#### HIGH-VOLTAGE POWER CIRCUIT

The high-voltage power circuit is a new technology that supports the new THS II system. By providing a newly developed high-voltage power circuit inside the power control unit, the voltage of the motor and the generator has been increased from 274V in THS to a maximum of 500V in THS II. As a result, electrical power can be supplied to the motor using a smaller current, thus contributing to an increase in efficiency.

#### POWER (P) = VOLTAGE (V) X CURRENT (I)

Power, which expresses the work performed by electricity within a given amount of time, is calculated by multiplying voltage by current. If the power necessary for driving the motor is held constant, the above formula indicates that doubling the voltage reduces the current by 1/2.

Next, by following Joule's Law (Calorie = Current<sup>2</sup>x Resistance), the power loss in terms of calories is reduced to 1/4 (1/2 Current x 1/2 Current) if the resistance is held constant. The high-voltage power circuit in THS II increases power by increasing the voltage while keeping the current constant. Furthermore, for the same power level, increasing the voltage and reducing the current reduces energy loss, resulting in higher efficiency.

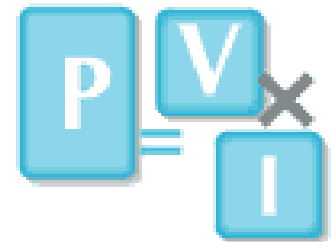

#### High-voltage electrical system

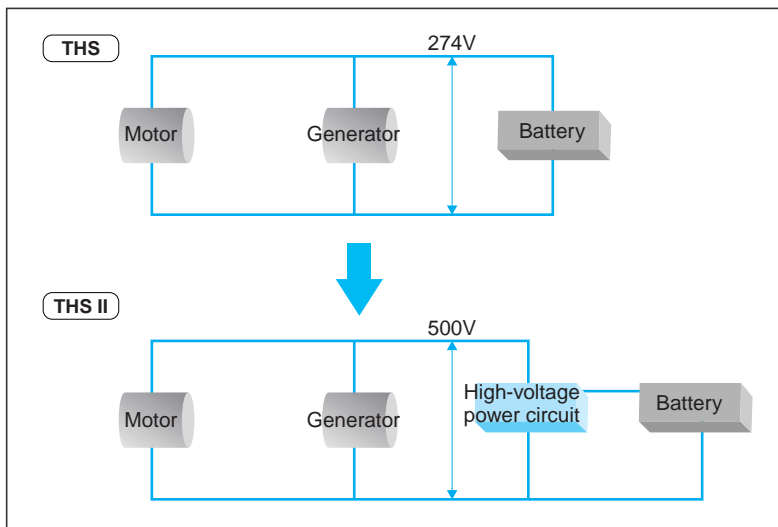

### Motor

The motor has been developed based on the technologies that Toyota has nurtured while working on electric vehicles. THS II uses an AC synchronous-type motor, which is a high-efficiency DC brushless motor with AC current. Neodymium magnets (permanent magnets) and a rotor made of stacked electromagnetic steel plates form a high-performance motor. Furthermore, by arranging the permanent magnets in an optimum V-shape, the drive torque is improved and the output is increased. This, combined with a larger power supply achieved by an increase in the power supply voltage, has increased power output by approximately 1.5 times from THS, i.e., to 50 kW from 33 kW, even with a motor of the same size, producing the highest output per unit of weight and volume in the world.

For motor control, a newly developed over-modulation control system has been added to the medium-speed range, in addition to the existing low- and high-speed control methods. By improving the pulse width modification method, the output in the medium-speed range has been increased by a maximum of approximately 30%.

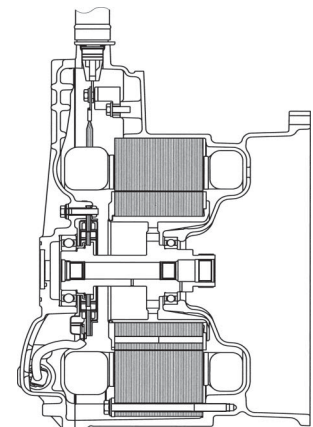

Motor cross-sectional view



## Generator

Like the motor, the generator is also an AC synchronous type. In order to supply sufficient power to the high-output motor, the generator is rotated at high speeds, increasing its output. Measures such as rotor strength enhancement have increased the rpm range for the maximum possible output from 6,500 (in the conventional type) to 10,000 rpm. This high rpm has significantly increased the power supply up to the medium-speed range, improving the acceleration performance in the low/medium-speed. As a result, an optimum combination of a high-output motor and an engine has been achieved.

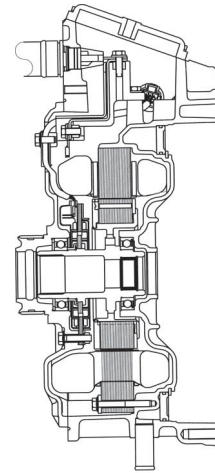

Generator cross-sectional view

### Motor performance curves

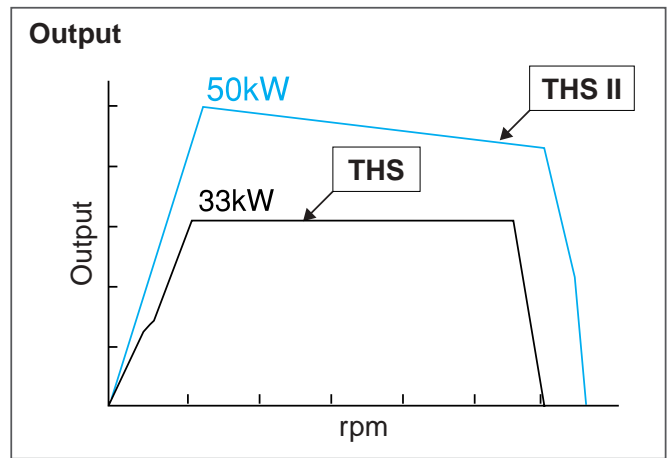
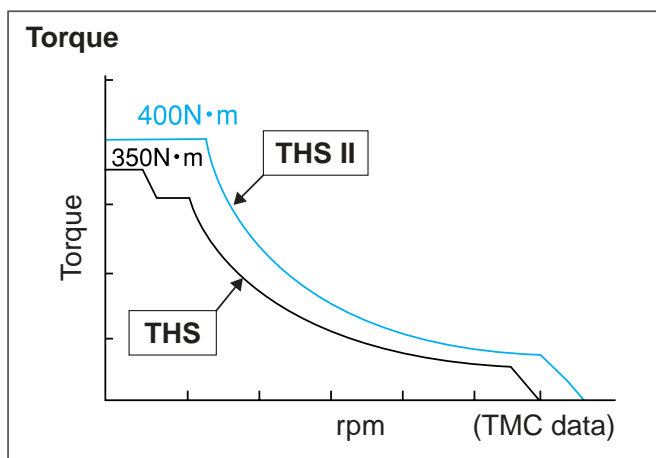

### Permanent magnet shape (conceptual diagram)

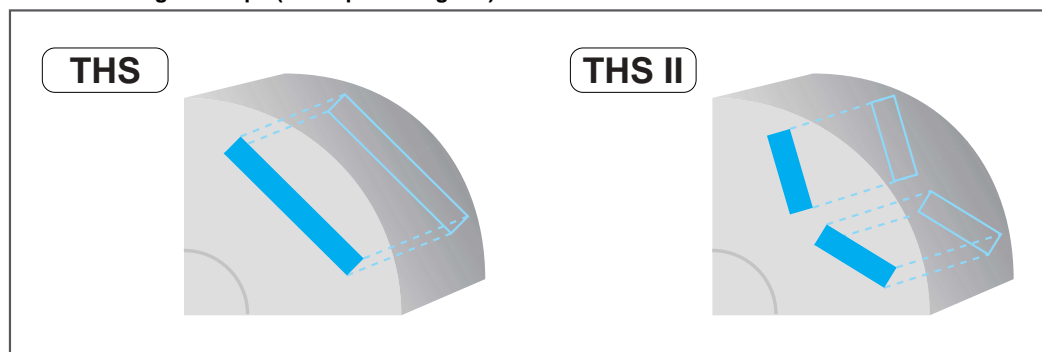

### Effect of over-modulation control

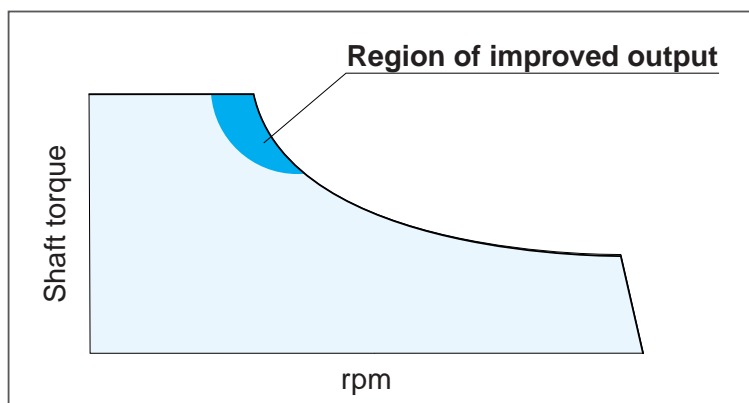

## Power Control Unit, Battery and Regenerative Braking System

The world's highest output density

### Power Control Unit

The power control unit contains an inverter that converts the DC from the battery into an AC for driving the motor and a DC/DC converter for conversion to 12V.

In THS II, a high-voltage power circuit that can increase the voltage from the power supply to 500V, has been added. Based on the relationship of  $\text{Power} = \text{Voltage} \times \text{Current}$ , increasing the voltage makes it possible to reduce the current, which in turn makes it possible to reduce the size of the inverter.

Also, because the control circuits have been integrated, the size of the power control unit itself has remained almost the same as before.



Power control unit

### Semiconductor Switching Device (IGBT)

This semiconductor switching device (IGBT: Insulated Gate Bipolar Transistor) boosts the voltage from the battery and converts the boosted DC power into AC power for driving the motor. Since the current that must be switched is large, minimizing heat generation is important. Therefore, Toyota has developed a unique transistor finely tuned down to the crystal level. This device is 20% smaller than the similar device used in THS and has achieved low heat generation and high efficiency.

### Hybrid Battery

In THS II, further enhancements have been made to the compact, high-performance nickel-metal hydride battery developed for THS. Having reduced the battery's internal resistance by improving the electrode material and by using an entirely new connection structure between (battery) cells, the new battery's input/output density is 35% better than the battery used in THS, achieving the highest output density (output per unit of weight) in the world. To maintain a constant charge, the new battery is discharged or receives charging energy from the generator and the motor, and therefore does not require external charging, as do electric vehicles.



Battery

**Battery output density comparison**

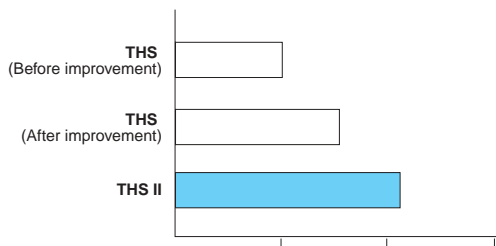

Note: The Japanese-market Prius was upgraded in August 2002.

**INVERTER AND CONVERTER**

An inverter is a device that converts a direct current (DC) from a battery into an alternating current (AC). When DC is converted into AC, it can be used to drive an AC motor. In THS II, a DC/DC high-voltage power circuit has been added in front of the inverter circuit. Because this converter can boost the voltage, the electrical power increases even at the same current level, resulting in higher output and higher torque for the motor drive.

**Regenerative Braking System**

A regenerative braking system is used which, during engine braking and braking using the foot brake, operates the electric motor as a generator, converting the vehicle’s kinetic energy into electrical energy, which is used to charge the battery. The system is particularly effective in recovering energy during city driving, where driving patterns of repeated acceleration and deceleration are common. When the footbrake is being used, the system controls the coordination between the hydraulic brake of the ECB and the regenerative brake and preferentially uses the regenerative brake, thereby recovering energy even at lower vehicle speeds. Furthermore, by improving the battery input performance, more energy is recovered.

Additionally, by reducing the friction loss in the drive system, such as in the transmission, the energy that used to be lost as driving system loss during deceleration is now recovered, significantly increasing the total amount of recovered energy.

**Motor and hydraulic braking allocation**

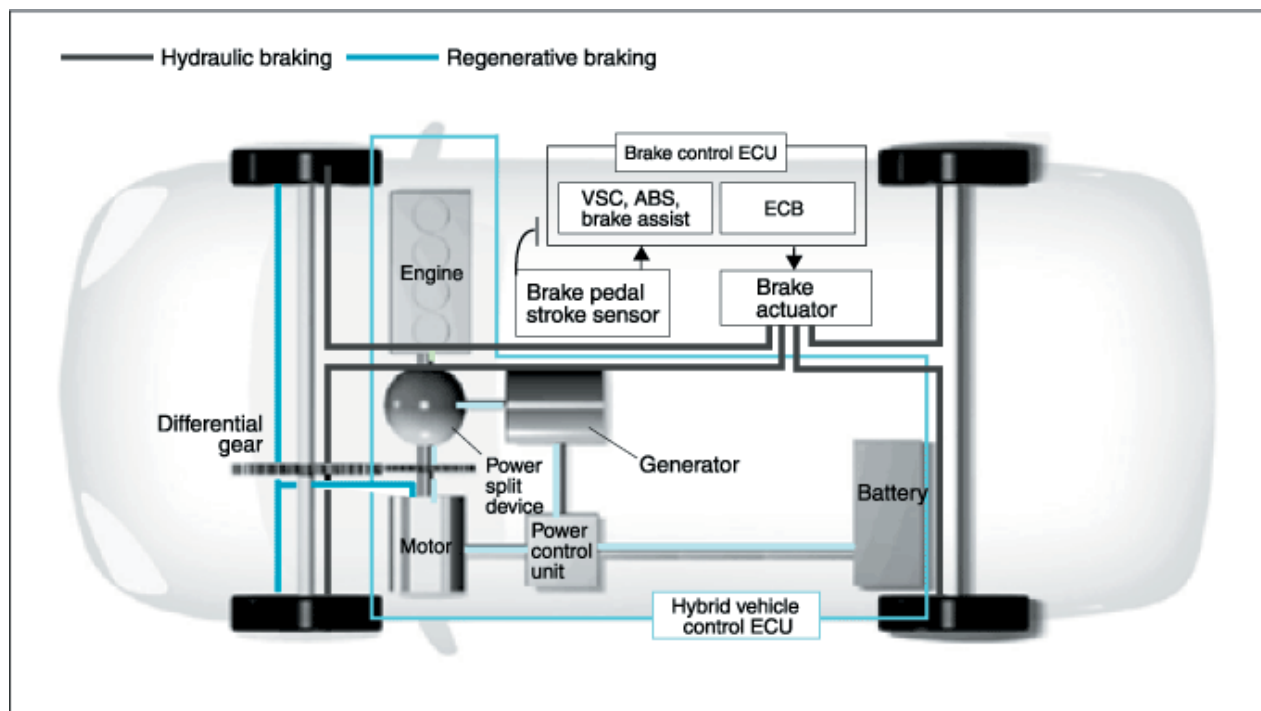

## Hybrid Transmission

A hybrid transmission that uses Toyota's original power split device

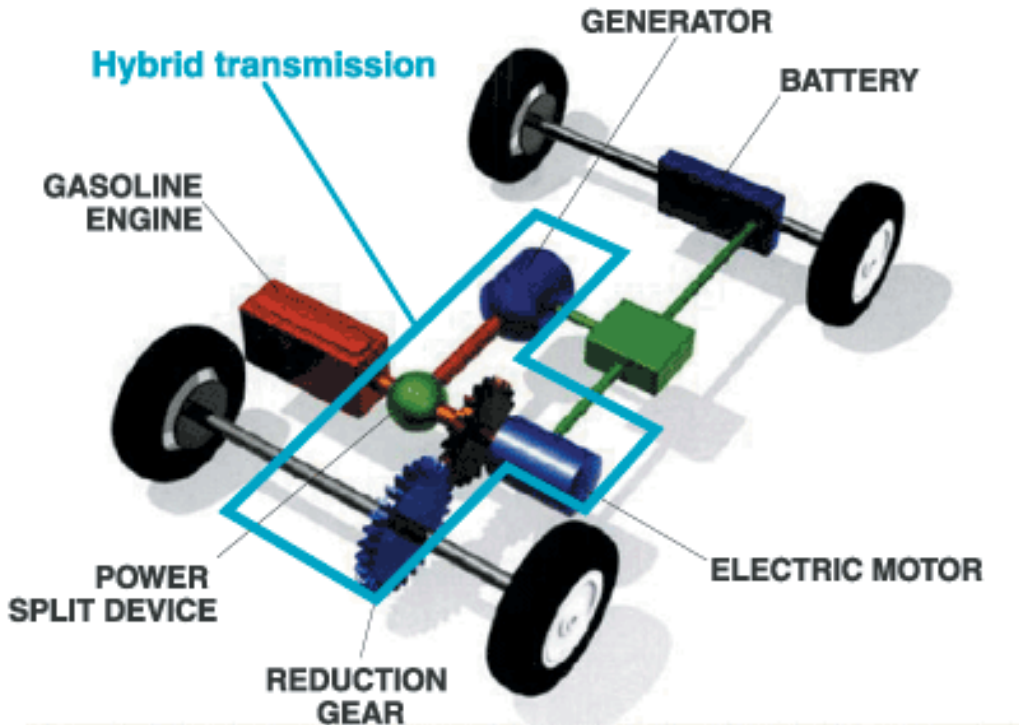

## Hybrid Transmission

The hybrid transmission consists of the power split device, the generator, the electric motor and the reduction gears, etc. The power from the engine is split into two by the power split device. One of the output shafts is connected to the motor and the wheels while the other is connected to the generator. In this way, the motive power from the engine is transmitted through two routes, i.e., a mechanical route and an electrical route.

An electronically controlled continuously variable transmission is also provided, which can change speed while continuously varying the rpm of the engine and the rpm of the generator and the electric motor (in relation to vehicle speed).

THS II also reduces friction loss by about 30% by using ball bearings in the transmission and low-friction.

## Power Split Device

The power split device uses a planetary gear. The rotational shaft of the planetary carrier inside the gear mechanism is directly linked to the engine, and transmits the motive power to the outer ring gear and the inner sun gear via pinion gears. The rotational shaft of the ring gear is directly linked to the motor and transmits the drive force to the wheels, while the rotational shaft of the sun gear is directly linked to the generator.

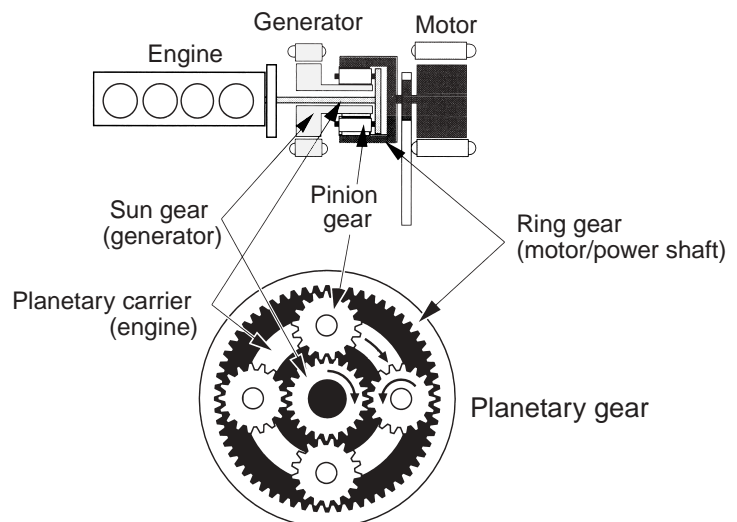

## Actions of the Engine, the Generator and the Motor

### 1) WHEN THE VEHICLE IS AT REST

The engine, the generator and the motor are stopped.

### 2) DURING START-UP

The vehicle starts moving using only the motor drive.

### 3) DURING ACCELERATION FROM START

The generator, which also has the function of an engine starter, rotates the sun gear and starts the engine. Once the engine has started, the generator begins generating electricity, which is used for charging the battery and supplied to the motor for driving the vehicle.

### 4) DURING NORMAL DRIVING

For the most part, the engine is used for driving. Electricity generation is basically not necessary.

### 5) DURING ACCELERATION

During acceleration from the normal driving state, the engine rpm is increased and, at the same time, the generator begins generating electricity. Using this electricity and electricity from the battery, the motor adds its driving power, augmenting the acceleration.

## Output Enhancement Based on High-Speed Rotation of the Generator

Because the maximum possible rpm of the generator has been increased, it can draw on higher engine rpm, thereby producing higher output. As a result, the amount of electricity created by the generator is increased, and this increased amount feeds the motor, thus leading to an increase in driving power.

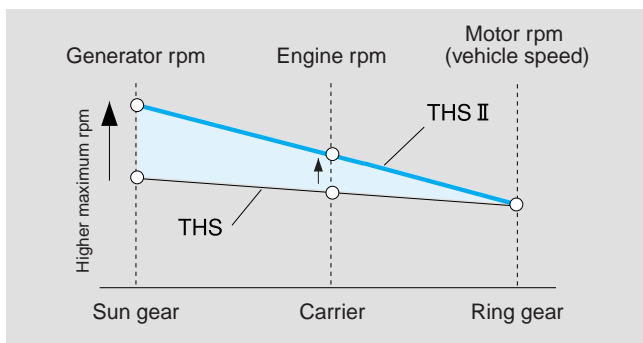

### Colinear graphing of planetary gear relationships

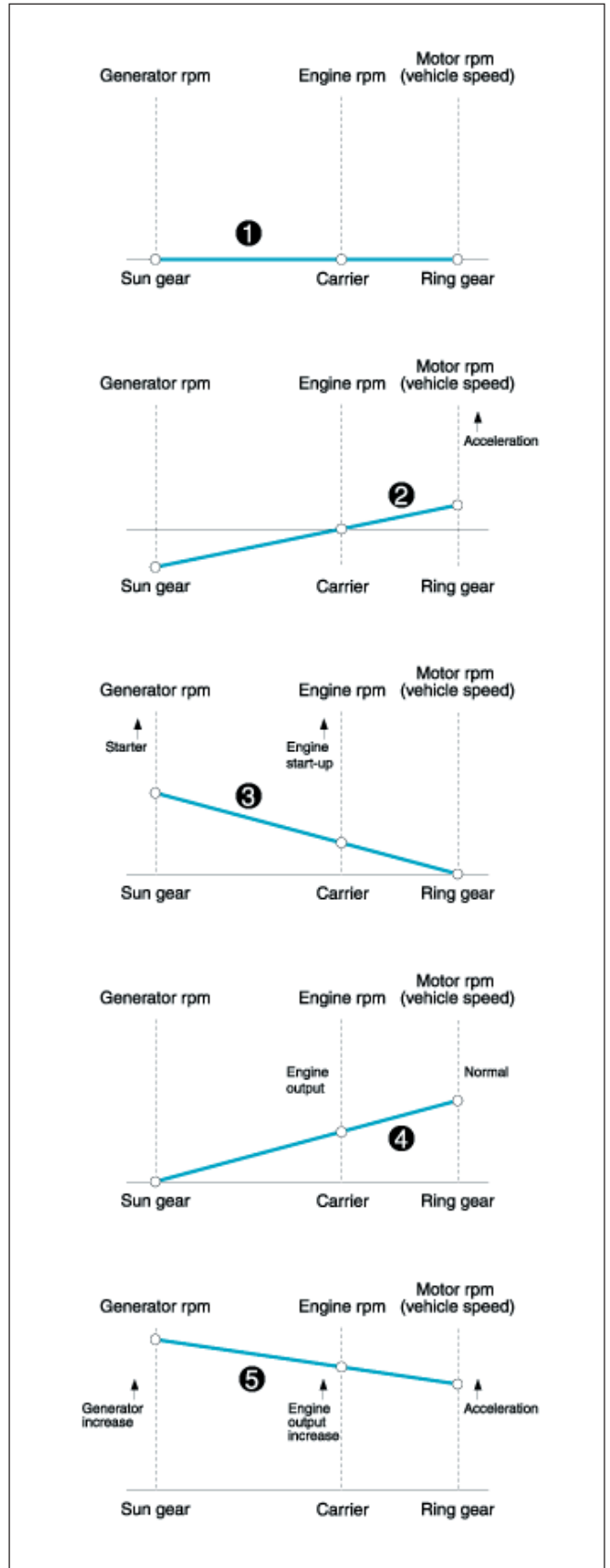

A linear relationship always exists between rotations per minute of the various gears on the vertical axis.

## Engine

The methodical pursuit of fuel efficiency improvement

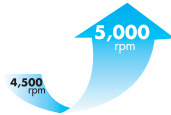

Using an engine that synergistically works with motor output and achieving high-efficiency operation and comfortable cruising through the synergistic effect of high-torque motor output

### High-Expansion Ratio Cycle

A 1.5-liter engine is used, which achieves high efficiency by using the Atkinson Cycle, one of the most heat-efficient, high-expansion ratio cycles. Because the expansion ratio ((expansion stroke volume + combustion chamber volume)/ combustion chamber volume) is increased by reducing the volume of the combustion chamber and the chamber is evacuated only after the explosion force has sufficiently fallen, this engine can extract all of the explosion energy.

\*1 Expansion ratio: (expansion stroke volume + combustion chamber volume)/combustion chamber volume

\*2 Compression ratio (compression stroke volume + combustion chamber volume)/combustion chamber volume

High expansion ratio conceptual diagram

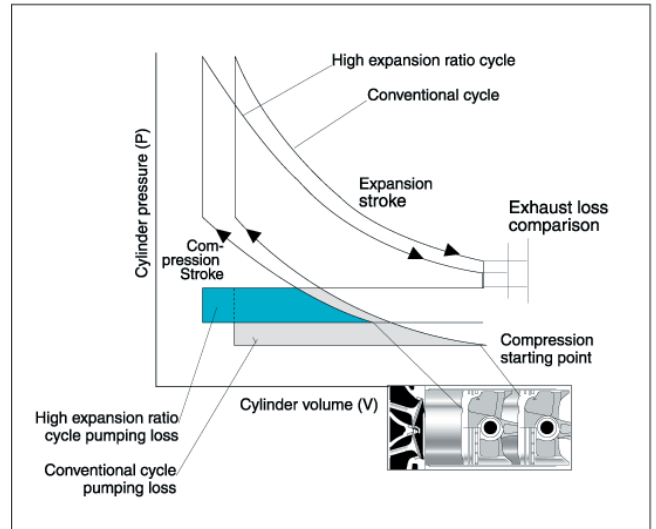

Engine cross-sectional view

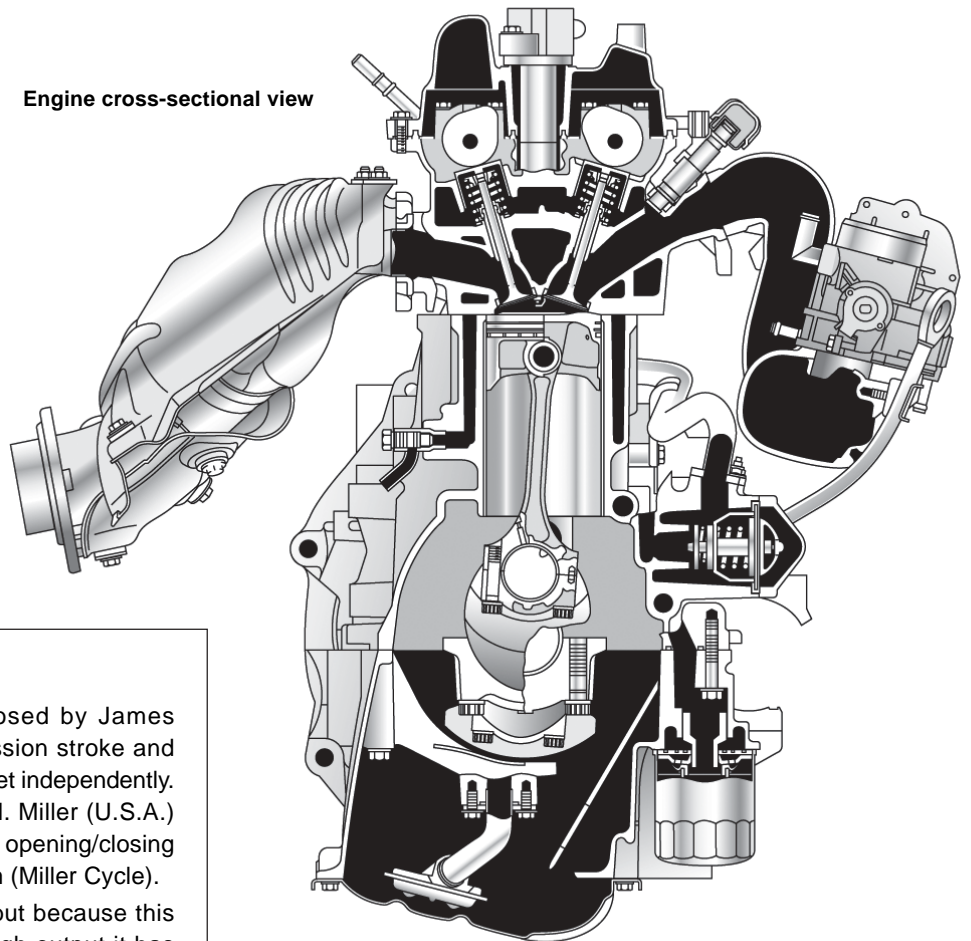

#### ATKINSON CYCLE

A heat cycle engine proposed by James Atkinson (U.K.) in which compression stroke and expansion stroke duration can be set independently. Subsequent improvement by R. H. Miller (U.S.A.) allowed adjustment of intake valve opening/closing timing to enable a practical system (Miller Cycle).

Thermal efficiency is high, but because this engine does not easily provide high output it has virtually no practical application unless used with a supercharger.

In conventional engines, because the compression stroke volume and the expansion stroke volume are nearly identical, the compression ratio ((compression stroke volume + combustion chamber volume)/combustion chamber volume) and the expansion ratio are basically identical. Consequently, trying to increase the expansion ratio also increases the compression ratio, resulting in unavoidable knocking and placing a limit on increases in the expansion ratio. To get around this problem, the timing for closing the intake valve is delayed, and in the initial stage of the compression stroke (when the piston begins to ascend), part of the air that has entered the cylinder is returned to the intake manifold, in effect delaying the start of compression. In this way, the expansion ratio is increased without increasing the actual compression ratio. Since this method can increase the throttle valve opening, it can reduce the intake pipe negative pressure during partial load, thus reducing intake loss.

**High Functionality**

VVT-i (Variable Valve Timing-intelligent) is used to carefully adjust the intake valve timing according to operating conditions, always obtaining maximum efficiency. Additionally, the use of an oblique squish compact combustion chamber ensures rapid flame propagation throughout the entire combustion chamber. High thermal efficiency, coupled with reductions in both the size and weight of the engine body through the use of an aluminum alloy cylinder block, and a compact intake manifold, etc., help improve the fuel efficiency.

**Output Improvement**

The engine's top revolution rate has been increased from the 4,500 rpm in conventional engines to 5,000 rpm, thereby improving output. Moving parts are lighter, piston rings have lower tension and the valve spring load is smaller, resulting in reduced friction loss. Furthermore, the increase of 500 rpm produces faster generator rotation, increasing the driving force during acceleration and further improving fuel efficiency.

**VVT-i valve timing (conceptual diagram)**

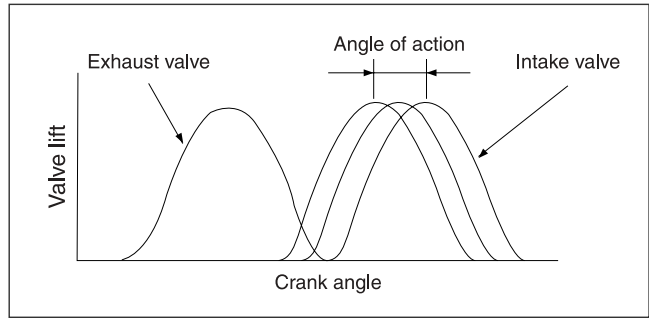

**Performance curve**

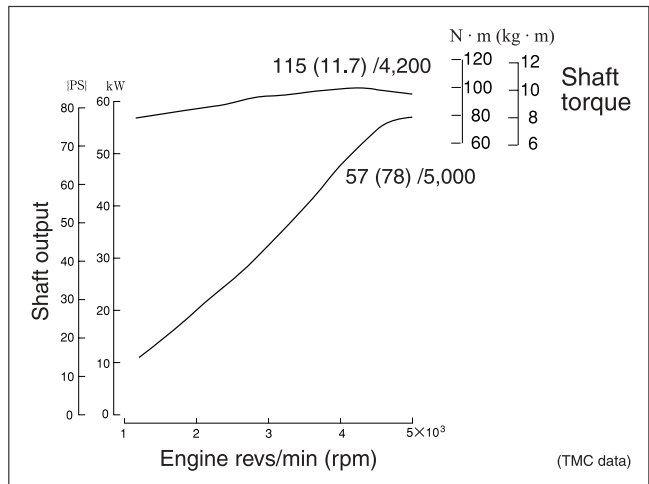

**Combustion chamber shape**

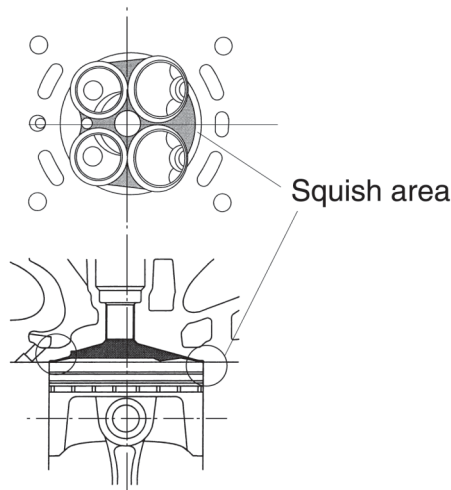

## System Control

Precise real-time control — sensing the driver's intentions

The system control of THS II maintains the vehicle at its maximum operating efficiency by managing the energy used by the entire vehicle, which includes the energy for moving the vehicle as well as the energy used for auxiliary devices, such as the air conditioner, heaters, headlights and navigation system. The system control monitors the requirements and operating states of hybrid system components, such as the engine, which is the source of energy for the entire hybrid vehicle; the generator, which acts as the starter for the engine and converts the energy from the engine into electricity; the motor, which generates the drive power for running the vehicle using the electrical energy from the battery; and the battery, which stores the electrical energy generated through power generation by the motor during deceleration. It also receives braking information being sent via the vehicle's control network, as well as instructions from the driver, such as the throttle opening and shift lever position. In other words, the system control of THS II monitors these various energy consumption statuses of the vehicle in real time and provides precise and fast integrated control so that the vehicle can be operated safely and comfortably at the highest possible efficiency.

System control (conceptual diagram)

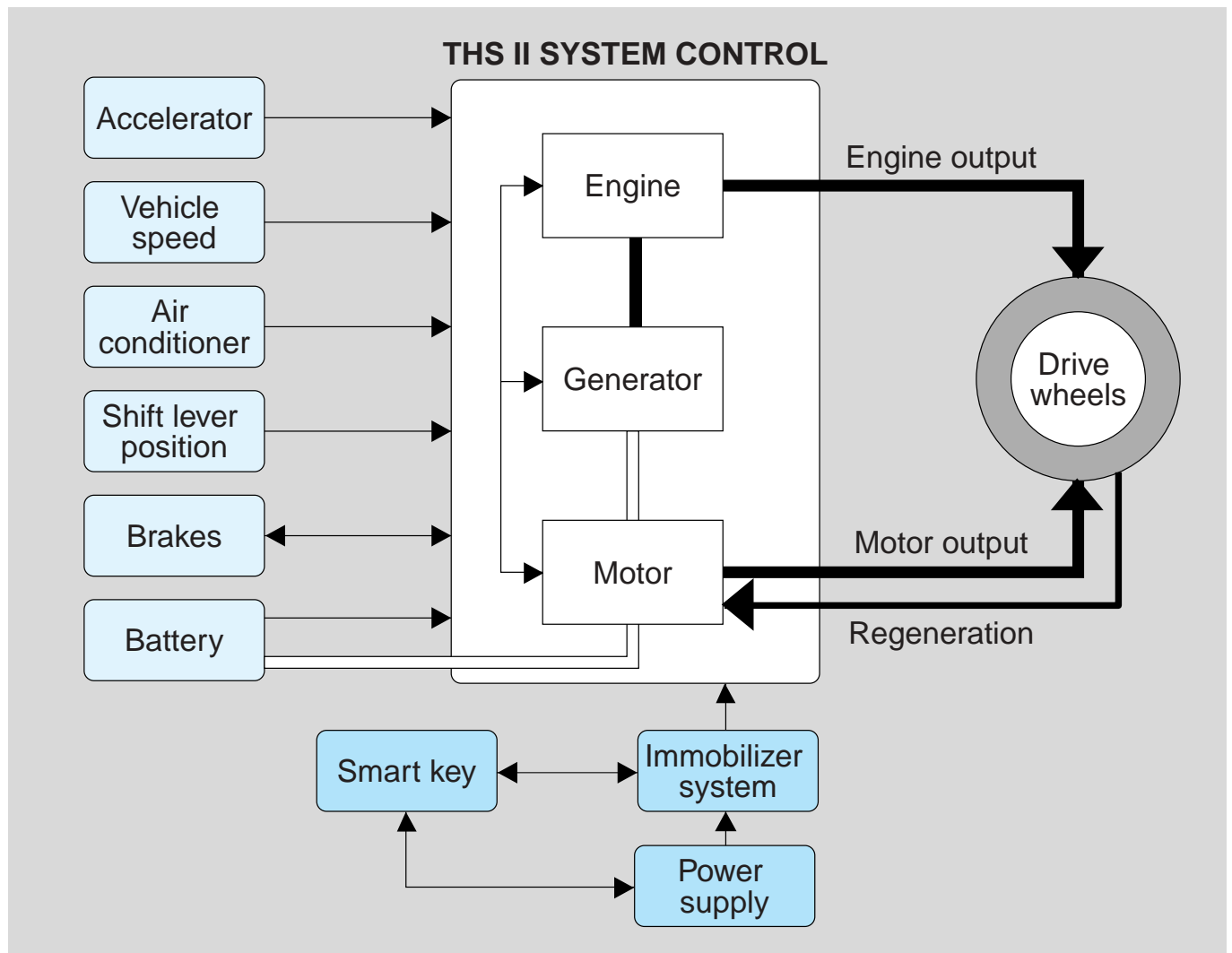



## System Start-up and Stop

Like modern jet planes, THS II hybrid vehicles use by-wire control, in which the driver's instructions are converted into electrical signals (through wires) to be used in integrated control. In by-wire control, system reliability is the highest control priority. When a smart key sends information indicating that the driver has gotten inside the vehicle, the system power supply is turned on.

First, whether or not the hybrid computer itself is functioning normally is monitored, and an operational check is performed before the ignition button is pressed.

When the ignition button is pressed, the system checks whether or not various sensors, the engine, the motor, the generator and the battery are functioning normally. Then, the switches for the components in the high-voltage system, such as the motor, the generator and the battery, are turned on, making the vehicle ready to run. This is the start-up control sequence. When the driver presses the ignition button again before leaving the vehicle, the components in the high-voltage system are disconnected and, after confirming that such systems are turned off, the hybrid computer shuts down.

Safety checks are also being carried out while the vehicle is moving, and, based on various types of information such as changes in driving conditions, the system controls the vehicle so that it can operate in an emergency mode in the unlikely event of failure in the hybrid system or lack of fuel.

## Engine Power Control

Engine power control is the basic control mechanism of THS II for always minimizing the energy consumption of the entire vehicle.

Based on the vehicle's operating state, how far the driver has depressed the acceleration pedal and the status signals from the battery computer, energy management control determines whether to stop the engine and run the vehicle using the electric motor only or to start the engine and run the vehicle using engine power.

When first started, the vehicle begins to operate using the motor unless the temperature is low or the battery charge is low. To run the vehicle using engine power, the engine is first started by the generator and at the same time, the system calculates the energy required by the entire vehicle. It then calculates the running condition that will produce the highest efficiency for producing this energy and sends an rpm instruction to the engine. The generator then controls the engine revolution to that rpm. The power from the engine is controlled by taking into account the direct driving power, the motor driving power from electrical generation, the power needed by the auxiliary equipment and the charging requirement of the battery. By optimizing this engine power control, THS II has advanced energy management for the entire vehicle and has achieved improved fuel efficiency.

Engine operating range

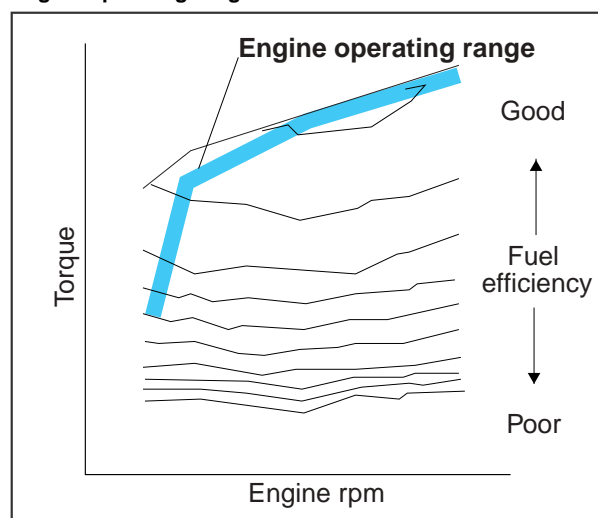

## Driving Control

The driving power of a vehicle with THS II is expressed as the combination of the direct engine driving power and the motor's driving power. The slower the vehicle's speed, the more the maximum driving power is derived from the motor's driving power. By increasing the generator rpm, THS II has made it possible to use the engine's maximum power starting at slower speeds than was possible with the current THS. It has also made it possible to significantly increase the maximum drive power by using a high-voltage, high-output motor that successfully improves power performance. Because the engine has no transmission and uses a combination of the direct driving power from the engine and the motor's driving power derived from electrical conversion, it can control the driving power by seamlessly responding to the driver's requirements, all the way from low to high speeds and from cruising with a low power requirement to full-throttle acceleration. (This is known as torque-on-demand.)

Additionally, the time required to start the engine during acceleration from motor-only drive has been reduced by 40%, greatly improving the acceleration response. In order to eliminate shock during engine start-up, the generator also precisely controls the stopping position of the engine's crank. To ensure that the vehicle's driving power is not affected even when a large load is applied, e.g., when the air-conditioner is turned on, precise driving power correction control is carried out, achieving smooth and seamless driving performance.

Driving power performance

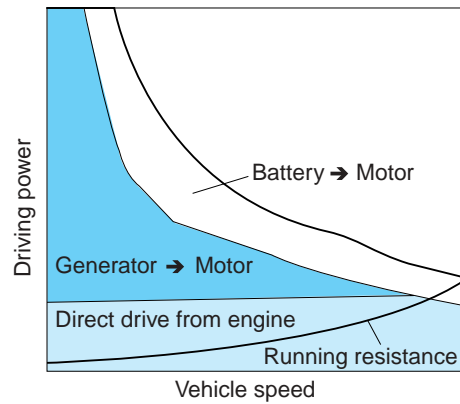

THS II drive power (conceptual diagram)

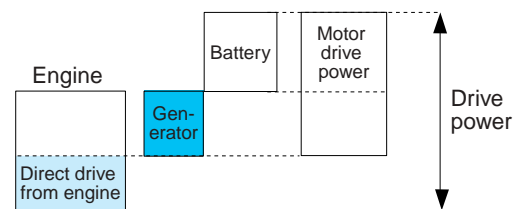

## Regenerative-brake Control

In THS II, the newly developed Electronically Controlled Braking System (ECB) controls the coordination between the hydraulic brake of the ECB and the regenerative brake and preferentially uses the regenerative brake; it also uses a high-output battery and increases the amount of energy that can be recovered and the range in which it can be recovered. The system increases overall efficiency and, thus, fuel economy.

### Improved regenerative braking

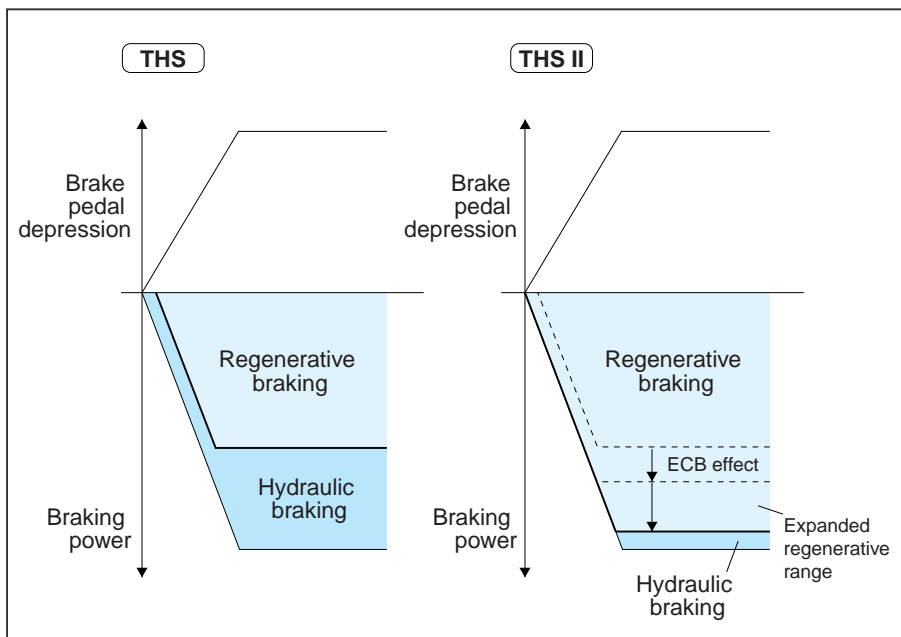

## THS II's Torque-on-Demand Control

Torque-on-Demand ensures that driving power is provided faithfully according to the driver's wishes under any driving conditions. THS II has further expanded this concept and has added an enhanced driver assist function, which ensures safe driving.

### 1) MOTOR TRACTION CONTROL

In THS, the engine, the generator, the motor and the wheels are linked together via the power split device. Furthermore, most of the engine power is converted into electrical energy by the generator, and the high-output and high-response motor drive the vehicle. Consequently, when the vehicle's driving power changes abruptly, e.g., wheel slippage on icy or other slippery surfaces and wheel locking during braking, a protection control similar to that used in conventional traction control is used to prevent abrupt voltage fluctuation and revolution increase of the planetary gear in the power split device. In THS II, we have advanced the parts protection function further and achieved the world's first motor traction control by utilizing the characteristics of a high-output, high-response motor. The goal of the motor traction control is to restore traction when wheel slippage on a snowy road is detected, for example, and inform the driver of the slipping situation. The basic requirement for safe vehicle operation is firm traction between the tires and the road surface. Motor traction control helps the driver maintain this state.

### 2) UPHILL ASSIST CONTROL

This is another driver assist function that is unique to the high-output motor THS II. This function prevents the vehicle from sliding downward when the brake is released during startup on a steep slope. Because the motor has a highly sensitive revolution sensor, it responsively senses the angle of the slope and the vehicle's descent and ensures safety by increasing the motor's torque.

#### Motor traction control

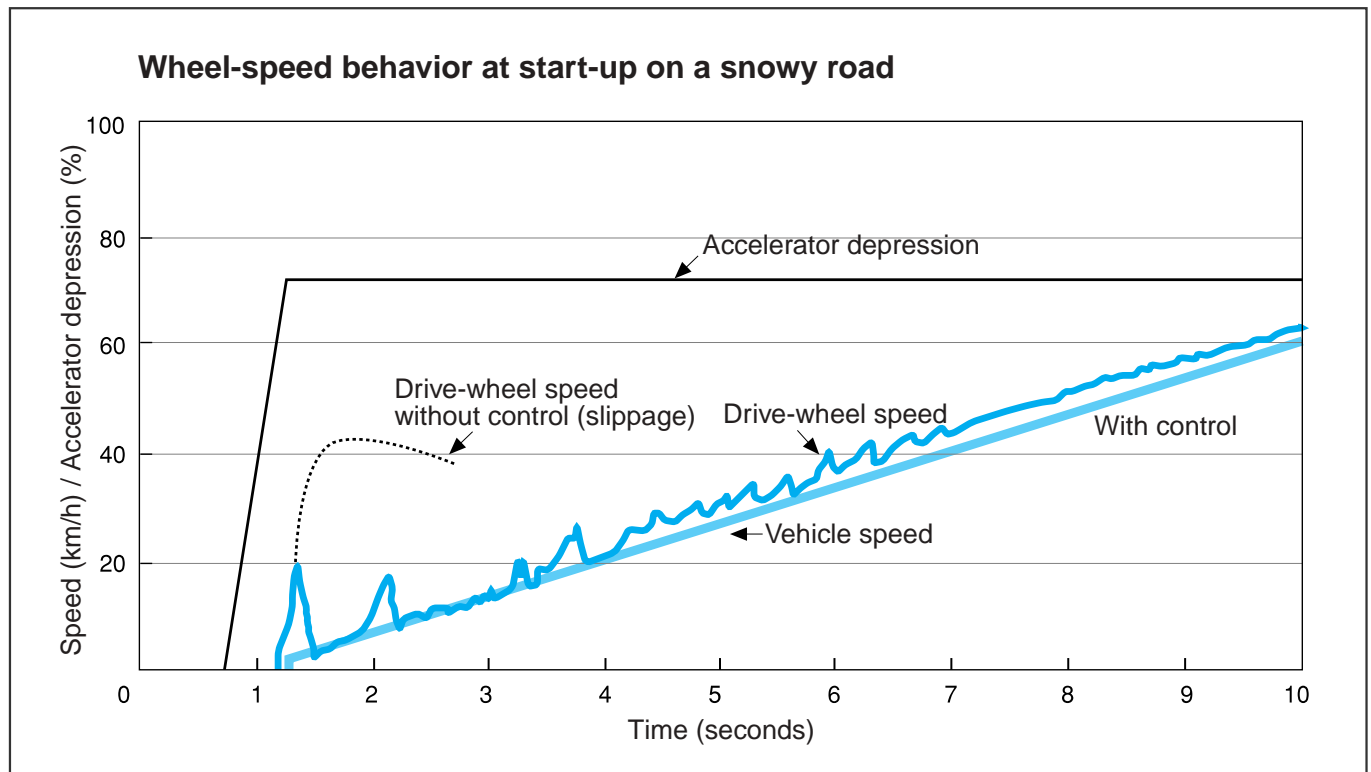

## Output Enhancement

Raising output through acceleration and environmental performance compatibility

### Acceleration Performance

#### INCREASED OUTPUT

Increasing the motor performance and raising the control voltage to 500V have improved the maximum output of the motor by 1.5 times from 33kW to 50kW. Coupled with this improvement, an increase in the maximum revolution of the generator from 6,500 to 10,000 rpm has increased the electrical power supplied to the motor at low to medium speeds, thereby increasing the motor output, and significantly boosted the system output, which also includes the engine's direct driving power. Furthermore, in the high-speed range, the engine, which is capable of faster revolutions and higher output, has boosted the system output.

System output comparison (TMC data)

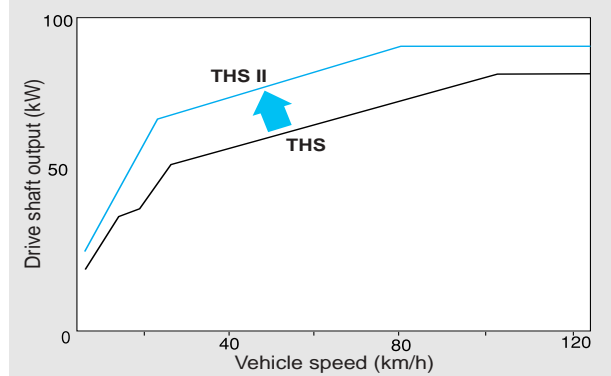

#### BETTER ACCELERATION PERFORMANCE

Especially as a result of improvements in output in the low to medium speed range, both at-start acceleration performance and overtaking acceleration performance have drastically improved. A performance level that exceeds that of a 2.0-liter gasoline engine vehicle has been achieved. High response and smooth acceleration based on the high-output motor have been improved, further advancing the hybrid driving experience.

Acceleration performance (TMC data)

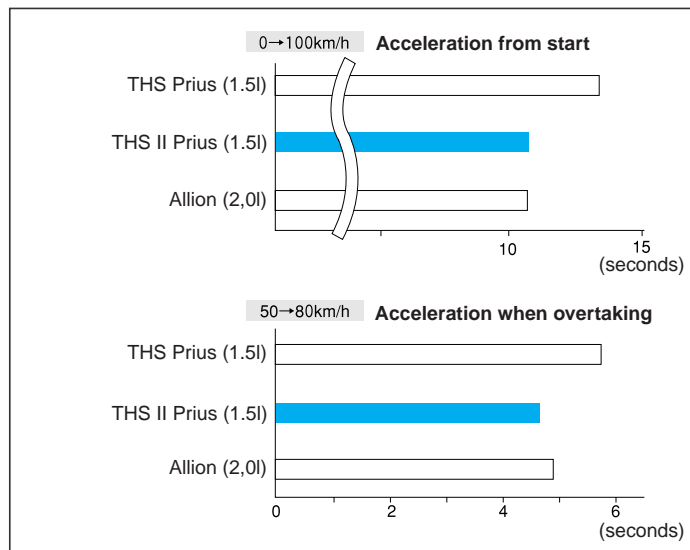

Acceleration sensation 50km/h → 80km/h

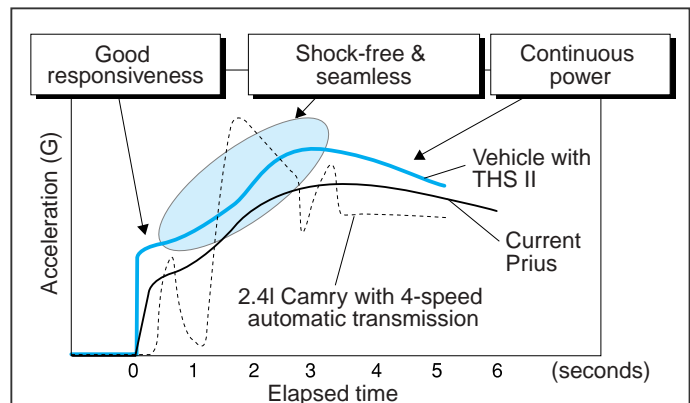

# Improved Environmental Performance

## OVERALL EFFICIENCY

THS II has achieved higher efficiency by improving hybrid energy management control and making improvements to the regenerative coordinated brake control, both of which are designed to improve the energy efficiency of the entire vehicle.

When compared in terms of overall efficiency (well-to-wheel efficiency), which indicates the efficiency of the entire process starting from the fuel manufacturing process, to the driving of a vehicle using that fuel, THS II's efficiency is striking. Its overall efficiency value has reached a level that exceeds even that of an FCHV (fuel cell hybrid vehicle), which is highly efficient, representing one step closer to creation of the ultimate eco-car.

Through technology such as that found in THS II, Toyota is working on development to the next step, including how such technology may apply to FCHVs, with an aim toward achieving even better efficiency.

## EMISSIONS

According to Toyota's in-house measurements, the emission level from a vehicle with THS II meets the Ultra-Low Emissions Level in Japan, as well as the planned zero-emission (ATPZEV) regulations in California, which are considered to be strictest in the world, and Europe's next-generation regulations (EURO IV).

Contribution to energy efficiency

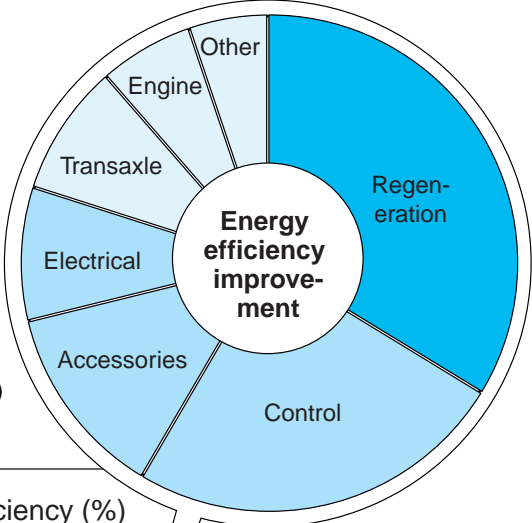

Fuel efficiency(%) x Vehicle efficiency(%) = Overall efficiency(%)

### Overall efficiency

	Fuel efficiency (well-to-tank) (%)	Vehicle efficiency (tank-to-wheel) (%)	Overall efficiency (%) (well-to-wheel)				
			0	10	20	30	40
Recent gasoline car	88	16	14%				
Prius (before improvement)	88	28	25%				
Prius (after improvement)		32	28%				
<b>Prius with THS II</b>		37	<b>32%</b>				
Toyota FCHV		58 Natural gas-H2	50	29%			
FCHV (target)	70	60	42%				

Note: The Japanese-market Prius was upgraded in August 2002.

## In-house Development and Production

Leading the hybrid evolution through in-house development and production

### Production Technology

Based on Toyota's corporate philosophy of internally developing core technologies, we have positioned the engine and the power split device, which form the basis of THS II, as well as electrical and electronic parts such as the generator and the power control unit, as the core units essential to the new system and have developed and are producing these core parts in-house.

By undertaking the development and production of motors and electronic parts in-house, which was unheard of for an automaker, Toyota brought the world's first hybrid vehicle to market and plans to play a leading role in the evolution of hybrid vehicles.

For example, in terms of production technology, we are working on improving the insulation performance of motors that run on high voltage, developing semiconductor transistor (IGBT) technology that supports large inverter output and improving soldering technologies to increase heat dissipation. The accumulation of these technologies is what has made THS II possible.

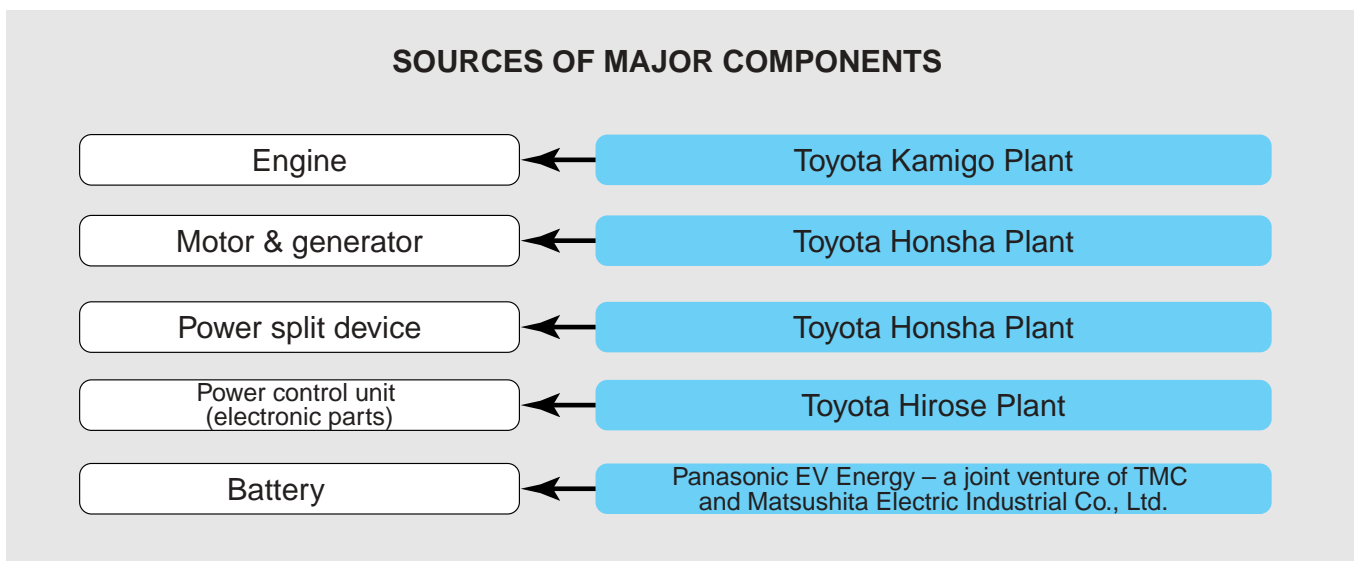

# Specifications of New Hybrid System

**Specifications of new hybrid system**

	Item	THS II	THS
Engine	Type	1.5 L gasoline (high-expansion ratio cycle)	←
	Maximum output in kw (Ps)/rpm	57 (78)/5,000	53 (72)/4,500
	Maximum torque in N-m (kg m)/rpm	115 (11.7)/4,200	115 (11.7)/4,200
Motor	Type	Synchronous AC motor	←
	Maximum output in kw (Ps)/rpm	50 (68)/1,200-1,540	33 (45)/1,040-5,600
	Maximum torque in N-m (kg m)/rpm	400(40.8)/0-1,200	350(35.7)/0-400
System*	Maximum output in kW (Ps)/vehicle speed km/h	82(113)/85 or higher	74 (101)/120 or higher
	Output at 85km/h in kW (PS)	82 (113)	65 (88)
	Maximum torque in N-m (kg m)/vehicle speed km/h	478(48.7)/22 or lower	421 (42.9)/11 or lower
	Torque at 22km/h in N-m (kg m)	478 (48.7)	378 (38.5)
Battery	Type	Nickel-metal hydride	←

\*Maximum combined engine and hybrid battery output and torque constantly available within a specified vehicle speed range (Toyota in-house testing)

**Cross-sectional view**

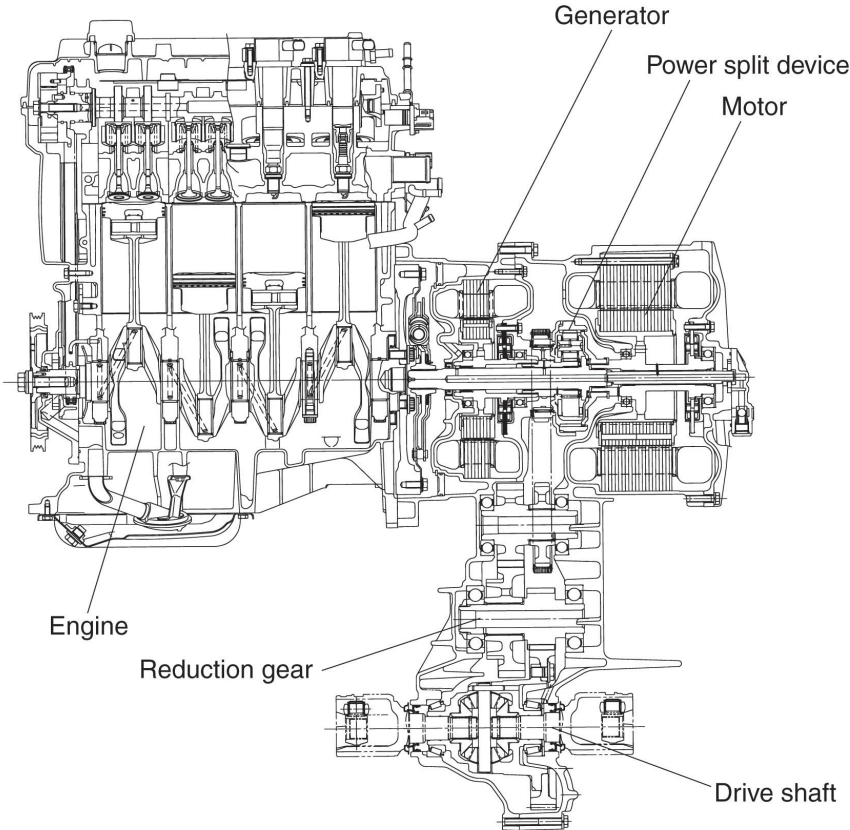

**TOYOTA**

[www.toyota.co.jp](http://www.toyota.co.jp)

